

SUPERIOR STUCCO ARCHITECTURAL SERIES

PEDIMENTS

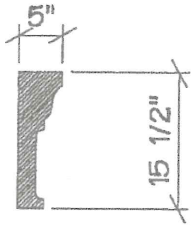

PD 500

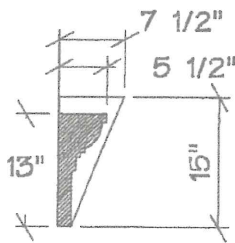
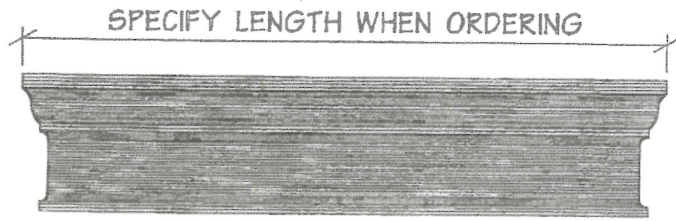

PD 501

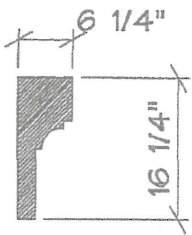
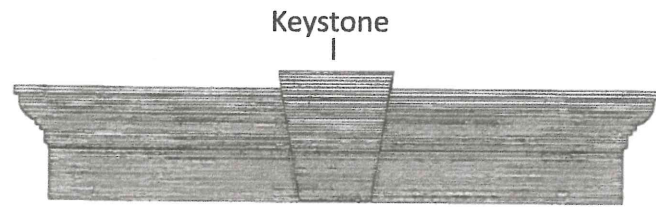

PD 502

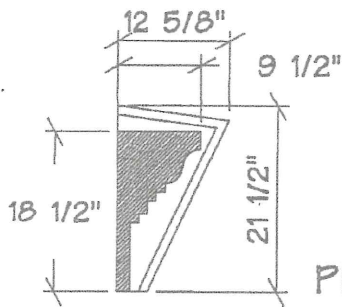
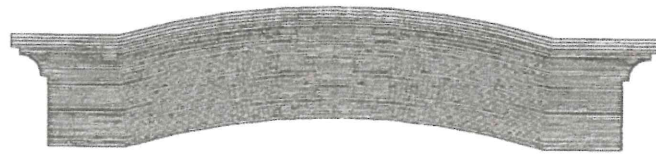

PD 503

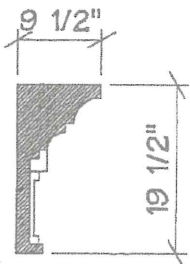
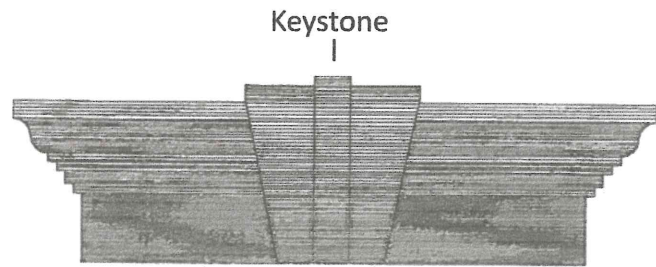

PD 504

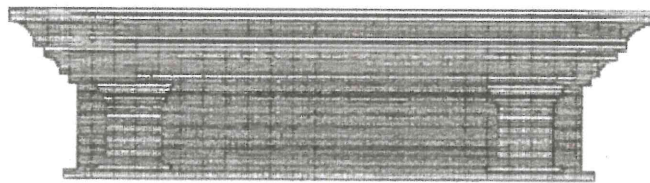

Pediments can be ordered with or without keystones. Please specify when ordering.